



US Edition
BOOKTIQUE®
Shelves, Tables,
In.Line Systems

HANNECKE DISPLAY SYSTEMS SHOP FURNITURE

HANNECKE

CONTENT.

FURNITURE

Welcome	3
In.Line Gondolas –	
Free standing gondolas	4
Shelves for In.Line Gondolas	8
In.Line Systems –	
Preconfigured Sets	10
Standard shelves	14
Tables	16
Booktique® –	
Shopfitting for retail	18
Preconfigured fixtures	20
More Information	23
Contact	24

Service ist important to us. As soon as you place an order with us, we handle it immediately with personal attention: our team in Northeim will assist you in selecting the right model, will track your order and ensures that the goods are packaged correctly for delivery to your retail outlets. Our shipping agents ensure that merchandise is delivered on time anywhere in the world.

We are pleased to assist you, if you have any questions as to how to use and make the most of our products over the long-term.

TELEPHONE EUROPE
+49 (0) 55 51 5 99-0
info@hannecke.de

TELEPHONE USA
+1 800 345 8631
+1 973 335 0434
info.usa@hannecke.com
www.hannecke.com

WELCOME.

Dear Customer,

Thank you for your interest in our furniture range and our shop-fitting solutions. The catalog shows references and examples of furniture, preconfigured fixtures as well as universal components to be added to your existing shelf system.

IN.LINE GONDOLAS

With mobile In.Line gondolas you can make efficiently use of the existing space in your location. If you want to highlight seasonal product or make special arrangements of merchandise, the flexible In.Line gondolas are easy to add on to your existing shop interior. In this context you may also view the range of tables we offer from stock.

IN.LINE SYSTEMS

With a large variety of designed-for-purpose displays you may upgrade your existing standard shelf systems. Browse complete sets which are suitable for retail sections of magazines, books, DVDs and media related product. All of the In.Line systems are also available by the component, which is a practical and at the same time cost-saving way to upgrade your media department. We offer standard diameters of 3' and 4' from stock.

BOOKTIQUE®

Booktique® is the modular furniture system to fit out your entire retail location. With preconfigured Booktique® fixtures you can grow your existing interior or convert parts from your shop space into a speciality department.

If you have any questions or wish further advise, please do not hesitate to contact us. We would be glad to receive your order.

Your Hannecke Team

OUR FINISHING RANGE

According to their specification and order #, the wooden bases and furniture are available from stock in the following options of laminated finish. The metal bases, frames and brackets are powder coated silver metallic.

IN.LINE SYSTEMS



RAL9006

IN.LINE GONDOLAS



Apple

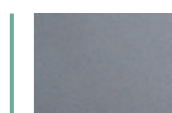

RAL9007

BOOKTIQUE®



Apple



Beech



Light Oak

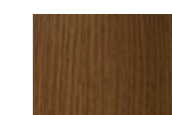

Dark Oak

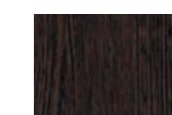

American Walnut

IN.LINE GONDOLAS FREE-STANDING GONDOLAS.

Mobile gondolas – extremely flexible for versatile applications. All of the shelves with 39" diameter simply hang into the slotted metal uprights, fully adjustable in height. You can add-on or exchange the various display shelves to accommodate other merchandise.



I201
IN.LINE GONDOLA
PAPERBACKS

Basic unit 70", wood grain apple, 4 castors, 2 locks,
2 multi-slotted metal uprights, grey metallic, 2 sight panels,
1 flat header, wood grain apple, 43 1/4" x 3",
4 shelf boards,
6 shelf boards with zig-zag inserts

Number of shelves	10
Visible facings	64
Capacity	250
Dimensions	43 1/4" x 19 3/4" x 65"

Order #
FMIG16KOM-2AP



I202
IN.LINE GONDOLA
PAPERBACKS, CD, DVD

Basic unit 79 1/2", wood grain apple, 4 castors, 2 locks,
2 multi-slotted metal uprights, grey metallic, 3 sight panels,
1 flat header, wood grain apple, 43 1/4" x 3",
14 metal bars with 6 pockets "P11" each

Number of shelves	14
Pockets per shelf	6
Visible facings	84
Capacity	340
Dimensions	43 1/4" x 19 3/4" x 79 1/2"

Order #
FMIG1914P11-1AP



I203
IN.LINE GONDOLA
MAGAZINES

Basic unit 70", wood grain apple, 4 castors, 2 locks,
2 multi-slotted metal uprights, grey metallic, 2 sight panels,
1 flat header, wood grain apple, 43 1/4" x 3",
8 metal bars with 6 pockets "PA4" each

Number of shelves	8
Pockets per shelf	6
Visible facings	48
Capacity	192
Dimensions	43 1/4" x 19 3/4" x 65"

Order #
FMIG168PA4AP

IN.LINE GONDOLAS FREE-STANDING GONDOLAS

- For books, magazines, DVD, non-book product
- Flexible by combining various display modules
- Slim design, available in different heights
- Both-sided presentation
- Mobility due to large castors with locks
- Other colors and finish on request

IN.LINE GONDOLAS.



I204
IN.LINE GONDOLA
NOTE BOOKS AND DIARIES

Basic unit 70", wood grain apple, 4 castors, 2 locks,
2 multi-slotted metal uprights, grey metallic, 2 sight panels,
1 flat header, wood grain apple, 43 1/4" x 3",
6 3-tier waterfall units

Number of shelves	6
Pockets per shelf	3
Visible facings	114
Capacity	228
Dimensions	43 1/4" x 19 3/4" x 65"

Order #
FMIG16SEGU1



I205
IN.LINE GONDOLA
MAGAZINES AND BROCHURES

Basic unit 70", wood grain apple, 4 castors, 2 locks,
2 multi-slotted metal uprights, grey metallic, 2 sight panels,
1 flat header, wood grain apple, 43 1/4" x 3",
8 adjustable acrylic shelves

Number of shelves	8
Pockets per shelf	1
Visible facings	64
Capacity	380
Dimensions	43 1/4" x 19 3/4" x 65"

Order #
FMIG168WRAP



I206
IN.LINE GONDOLA
CALENDARS AND BLISTER PACKS

Basic unit 79 1/2", wood grain apple, 4 castors, 2 locks,
2 multi-slotted metal uprights, grey metallic,
1 flat header, wood grain apple, 43 1/4" x 3",
3 perforated metal panels,
25 single hooks, 4 3/4"

Number of hooks	25
Dimensions	43 1/4" x 19 3/4" x 79 1/2"

Order #
FMIG1925EHAP



I207
IN.LINE GONDOLA
MERCHANDISE PRODUCTS

Basic unit 70", wood grain apple, 4 castors, 2 locks,
2 multi-slotted metal uprights, grey metallic,
1 flat header, wood grain apple, 43 1/4" x 3",
2 perforated metal panels,
8 flat shelves, depth: 12"

Number of shelves	8
Dimensions	43 1/4" x 19 3/4" x 65"

Order #
FMIG16KOMAP2

SHELVES FOR IN.LINE GONDOLAS.

CREATE YOUR OWN GONDOLA:

You can mix and match the displays to your individual needs on both sides of the basic element. All of the shelves and components simply hang into the slotted metal uprights.

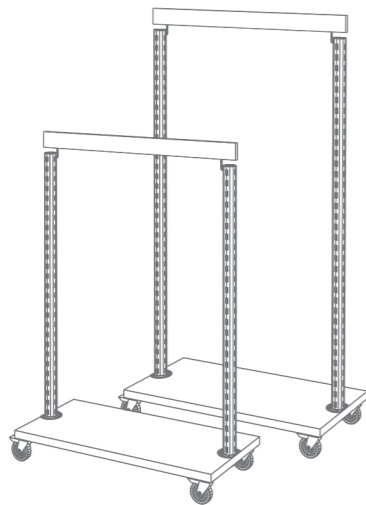

I208 BASIC UNIT 70"

Basic unit 70", wood grain apple, 4 castors, 2 locks, 2 multi-slotted metal uprights, grey metallic, 1 flat header, wood grain apple, 43 1/4" x 3 1/4"

Dimensions	43 1/4" x 19 3/4" x 65"
------------	--------------------------------

Order #	GMGOKOM1600GU
---------	----------------------

I209 BASIC UNIT 79 1/2"

Basic unit 79 1/2", wood grain apple, 4 castors, 2 locks, 2 multi-slotted metal uprights, grey metallic, 1 flat header, wood grain apple, 43 1/4" x 3 1/4"

Dimensions	43 1/4" x 19 3/4" x 79 1/2"
------------	------------------------------------

Order #	GMGOKOM1990GU
---------	----------------------

I210 SHELF BOARD "A4"

Shelf board for the face-out presentation of books up to 12", wood grain apple

Shelf depth	3 1/4"
Shelf back	9 1/2"
Dimensions	39" x 4 1/4" x 10 1/4"

Order #	FIWR100-3AP
---------	--------------------

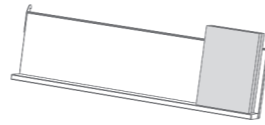

I211 SHELF BOARD "TB"

Shelf board for the spine- and face-out presentation of books up to 8 1/4", wood grain apple

Shelf depth	7"
Shelf back	4 1/4"
Dimensions	39" x 7 3/4" x 5"

Order #	FIWR100-2AP
---------	--------------------

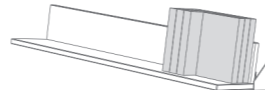

I212 SHELF BOARD, FLAT

Universal shelf board, flat, for merchandise products, wood grain apple

Shelf depth	12 1/4"
Dimensions	39" x 12 1/4" x 3/4"

Order #	FIRB100AP
---------	------------------



I213 ZIG-ZAG INSERT "A4"

Zig-Zag insert for books up to 12", plastic, grey, fit for I211

Number of pockets	6
Pocket width	7 1/2"
Pocket depth	3 1/4"
Dimensions	39" x 5 1/2" x 7 1/4"
Packaging unit	5

Order #	FISZ100-7GU4
---------	---------------------

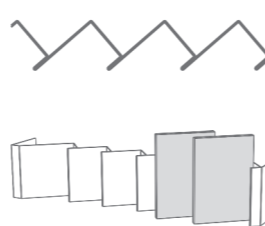

I214 ZIG-ZAG INSERT "TB"

Zig-zag insert for books up to 8 1/4", plastic, grey, fit for I211

Number of pockets	7
Pocket width	4 3/4"
Pocket depth	3 1/4"
Dimensions	39" x 3 1/2" x 5 1/4"
Packaging unit	7

Order #	FISZ100-6GU4
---------	---------------------

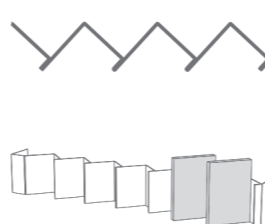

I215 ACRYLIC SHELF "VA"

Acrylic shelf for magazines, catalogs, and brochures, adjustable angle of slope

Pocket depth	4"
Shelf back	11 3/4"
Dimensions	39" x 4" x 11 3/4"

Order #	FISE100-7FL
---------	--------------------

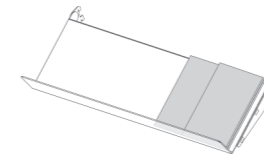

I216 WATERFALL UNIT

3-tier waterfall unit for books, booklets and greeting cards, clear acrylic

Pocket width	38 1/2"
Pocket depth	2 1/4"
Dimensions	39" x 1" x 14 1/2"

Order #	FISE100FL
---------	------------------

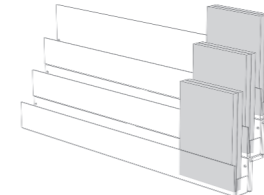

I217 IN.LINE SYSTEM "PA4"

Metal bar with 6 pockets "PA4" for magazines, catalogs and brochures

Number of pockets	6
Pocket width	8 3/4"
Pocket depth	1 1/4"
Dimensions	39" x 6" x 7 3/4"

Order #	FIS100PA4BGU
---------	---------------------

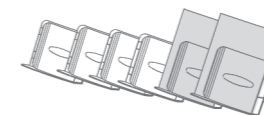

I218 IN.LINE SYSTEM "P11"

Metal bar with 6 pockets "P11" for paperbacks, CD's and DVD's

Number of pockets	6
Pocket width	4 1/4"
Pocket depth	4 1/4"
Dimensions	39" x 4 3/4" x 7 3/4"

Order #	FIS100P11-2BGU
---------	-----------------------

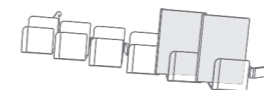

I219 IN.LINE SYSTEM "PIC"

Metal bar with 14 pockets "PIC" for maps, greeting cards and leaflets

Number of pockets	14
Pocket width	4 1/2"
Pocket depth	1 1/4"
Dimensions	39" x 6" x 7 3/4"

Order #	FIKT100PIC-3GU
---------	-----------------------

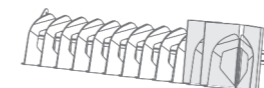

I220 PERFORATED METAL PANEL

Perforated metal panel for single and double hooks, also usable as magnet board, grey metallic

Dimensions	35 3/4" x 19 3/4" x 3/4"
------------	---------------------------------

Order #	GMWLBGU-1
---------	------------------

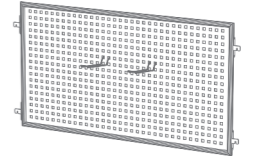

I221 SIGHT PANEL

Plastic, grey metallic

Dimensions	35 3/4" x 19 3/4" x 1/16"
------------	----------------------------------

Order #	GMWSBGU
---------	----------------

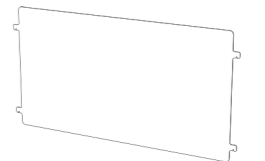

I222 SCANNER BAR

Scanner bar for signage or scanner stripes, to clip onto shelf boards (fit for I210, I211, I212)

Dimensions	39" x 1 1/4" x 1 1/2"
------------	------------------------------

Order #	RKPSCA39FL
---------	-------------------



I223 SINGLE- /DOUBLE HOOK

Chrome, 4 3/4" (fit for I220)

Packaging unit	25
Length	4 3/4"

Order #	RFHD120.GZ (double hook)
	RFHE120.GZ (single hook)

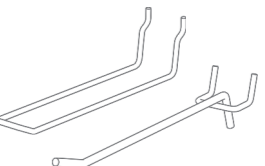

IN.LINE SYSTEMS PRECONFIGURED SHELF SETS.

Hannecke In.Line systems are designed to suit a broad range of applications:

Traditional presentations such as built-in spinners, zig-zag shelves and tiered inserts enable you to improve your presentation. In the following we show pre-configured shelf sets for your existing standard racks.



E201 IN.LINE SET CHILDREN AND TEENAGE BOOKS

Set of:
4 shelf boards with zig-zag inserts up to 8 1/4" books,
1 2-tiers zig-zag base unit up to 11 3/4" books

	36"	48"
Visible facings	36	48
Capacity	180	240

Order #
FISETKOM-16GU (diameter 36")
FISETKOM-17GU (diameter 48")

IN.LINE SYSTEMS DISPLAY MODULES

- Large variety of shelves and displays for books, magazines, DVD and other media product
- Universal Hannecke hook adapts to any standard shelving and slotted metal uprights
- Standards in 36" and 48" available from stock
- Other dimensions and colors on request



E202 IN.LINE SET BESTSELLER AND PAPERBACKS

Set of:
1 cross header panel, 4", flat, printed "Bestseller"
2 shelf boards with scanner bar "TOP 10",
1 shelf board with zig-zag insert up to 8 1/4" books,
1 3-tiers zig-zag base unit up to 8 1/4" books

	36"	48"
Visible facings	41	53
Capacity	137	177

Order #
FISETKOM-18GU (diameter 36")
FISETKOM-19GU (diameter 48")

► Please ask for other spinner models for different types of books, CD's, DVD's, magazines etc.



E203 BUILT-IN SPINNER SET MAGAZINES AND PAPERBACKS

Set of:
1 spinner with 4 tiers "RCR" with 8 pockets each for magazines,
1 spinner with 7 tiers "G1" with 8 pockets each for paperbacks,
each with a round, grey header, 4",
1 double transom bar for 36" – 48" diameter

	36"/48"
Visible facings	32 Magazines 56 Pocket books
Capacity	224 Magazines 280 Pocket books

Order #
FISETKOM-20GU

IN.LINE SYSTEMS.



E204
IN.LINE SET
CD, DVD, BLU-RAY

Set of:
7 zig-zag metal bars with 6 to 8 pockets "P11" each
1 flat, grey, header, printed "DVD Video"

	36"	48"
Visible facings	42	56
Capacity	294	392

Order #
FISETP11DVD2 (diameter 36")
FISETP11DVD3 (diameter 48")



E205
IN.LINE SET
"SPECIAL INTEREST" MAGAZINES

Set of:
5 zig-zag metal bars with 6 to 7 pockets "PA4" each

	36"	48"
Visible facings	30	35
Capacity	180	210

Order #
FISETPA4-3GU (diameter 36")
FISETPA4-4GU (diameter 48")



E206
IN.LINE SET
COMICS

Set of:
4 shelf boards with zig-zag inserts up to 8 1/4" books,
1 3-tiers zig-zag base unit up to 11 3/4" books

	36"	48"
Visible facings	41	51
Capacity	305	375

Order #
FISETKOM-21GU (diameter 36")
FISETKOM-22GU (diameter 48")



E207
IN.LINE SET
MAGAZINES

Set of:
1 6-tiers waterfall unit,
1 acrylic shelf for mass market titles,
1 4-tiers waterfall unit

	36"	48"
Visible facings	54	65
Capacity	290	350

Order #
FISETKOM-23GU (diameter 36")
FISETKOM-24GU (diameter 48")

SHELVES FOR EXISTING IN.LINE RACKS.

CREATE YOUR OWN IN.LINE SET:

In.Line shelves to accommodate your requirements: All of the shelves are available from stock in standard diameters of 36" and 48".

E208 SHELF BOARD WITH ZIG-ZAG INSERT "A4"

Shelf board with zig-zag insert for books up to 11 3/4"

	36"	48"
Number of pockets	5	6
Pocket width	6 3/4"	6 3/4"
Pocket depth	4"	4"

Order #
FIWR36SZGU (36")
FIWR48SZGU (48")

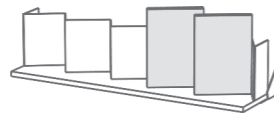

E209 SHELF BOARD WITH ZIG-ZAG INSERT "TB"

Shelf board with zig-zag insert for books up to 8 1/4"

	36"	48"
Number of pockets	6	8
Pocket width	4 1/4"	4 1/4"
Pocket depth	4"	4"

Order #
FIWR36SZ1GU (36")
FIWR48SZ1GU (48")

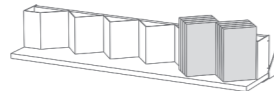

E210 BESTSELLER SHELF BOARD

Shelf board for the spine- and face-out presentation of books up to 8 1/4", acrylic divider on each end, scanner bar for "Top 10" signage

	36"	48"
Shelf width	37 3/4"	47 3/4"
Shelf depth	7"	7"
Shelf back	4 1/4"	4 1/4"

Order #
FIWR36-1GU (36")
FIWR48-1GU (48")

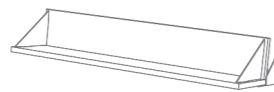

E211 WATERFALL UNIT "SC-6"

6-tier waterfall unit for the presentation of magazines made from high resistant clear acrylic. In combination with E212 and E213 as a complete wall unit

	36"	48"
Pocket width	39"	48 3/4"
Pocket depth	2 1/4"	2 1/4"

Order #
FISE36-5FL2 (36")
FISE48-5FL1 (48")

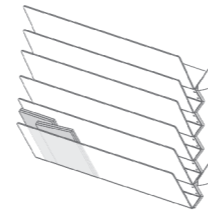

E212 ACRYLIC SHELF BOARD "SC-1"

High resistant, clear acrylic shelf board for mass market magazines

	36"	48"
Pocket width	39"	48 3/4"
Pocket depth	5"	5"

Order #
FISE36-3FL2 (36")
FISE48-3FL2 (48")

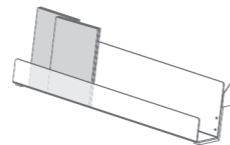

E213 WATERFALL UNIT "SC-4"

4-tier waterfall unit for the presentation of magazines made from high resistant clear acrylic. In combination with E211 and E212 as a complete wall unit

	36"	48"
Pocket width	39"	48 3/4"
Pocket depth	2 1/4"	2 1/4"

Order #
FISE36-6FL (36")
FISE48-6FL (48")

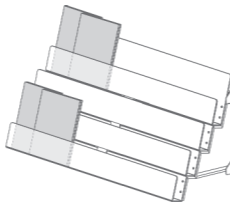

E214 ZIG-ZAG SHELF BOARD "NEWSPAPER"

Zig-zag unit for newspapers with clear acrylic pocket dividers, height 10 1/4"

	36"	48"
Number of pockets	6	8
Pocket width	13"	13"
Pocket depth	4"	4"

Order #
FISD36GU-1 (36")
FISD48GU-1 (48")

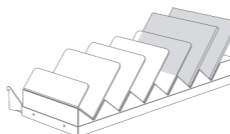

E215 ZIG-ZAG BASE UNIT "A4"

2-tier zig-zag base unit for books up to 11 3/4"

	36"	48"
Number of pockets	12	16
Pocket width	5 3/4"	5 3/4"
Pocket depth	3 1/2"	3 1/2"

Order #
FISD36SZ1GU (36")
FISD48SZ1GU (48")

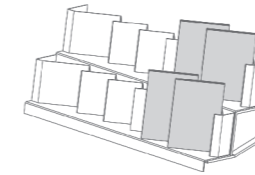

E216 ZIG-ZAG BASE UNIT "TB"

3-tier zig-zag base unit for books up to 8 1/4"

	36"	48"
Number of pockets	21	27
Pocket width	4 1/4"	4 1/4"
Pocket depth	3 1/2"	3 1/2"

Order #
FISD36SZGU (36")
FISD48SZGU (48")

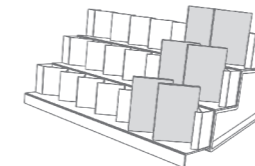

E217 HEADER

Cross header panel, 4", flat, optional printed: "DVD Video" (black/grey) or "Bestseller" (red/white)

Order #
FIKFK36GUDVD (Printed DVD, 36")
FIKFK48GUDVD (Printed DVD, 48")
FIKFK36GUBES (Printed Bestseller, 36")
FIKFK48GUBES (Printed Bestseller, 48")



E218 IN.LINE SYSTEM "P11"

Metal bar with 6 to 8 pockets "P11" for paperbacks, CD's and DVD's

	36"	48"
Number of pockets	6	8
Pocket width	4 1/4"	4 1/4"
Pocket depth	4 1/4"	4 1/4"

Order #
FIS36P11BWE (36")
FIS48P11BWE (48")

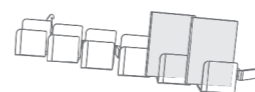

E219 IN.LINE SYSTEM "PA4"

Metal bar with 6 to 8 pockets "PA4" for magazines, catalogs and brochures

	36"	48"
Number of pockets	6	8
Pocket width	8 3/4"	8 3/4"
Pocket depth	1 1/4"	1 1/4"

Order #
FIS36PA4BWE (36")
FIS48PA4BWE (48")

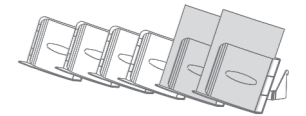

► BRACKETS FOR BUILT-IN SPINNERS

E220 DOUBLE TRANSOM BAR

For built-in spinners, adjustable for width 36" – 48"

Order #
GSF05BWE-US (36"/48")

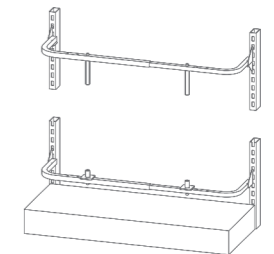

E221 BOTTOM BRACKET WITH METAL POLE

For built-in spinners, 35 1/2" metal pole

Order #
GSF2ABWE

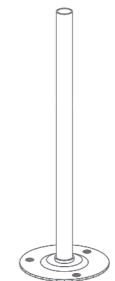

E222 BASE AND TOP ADAPTING BRACKET

For built-in spinners, top 10" metal pole, bottom 1 1/4" metal pole

Order #
GSF01BWE

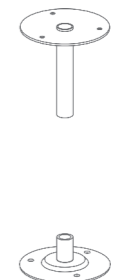

TABLES ARRANGE AND DECORATE.

These tables enable you to stage your product and merchandise in your shop or department. Whether it is mass-market product or the very special presentation of quick turning Bestsellers, these tables work for your goal. Acrylic panels hold your exchangeable posters and Bestseller lists.



ACCESSORY

A3 FORMAT SIGNHOLDER

Metal bar with 2 sided clear acrylic signholder for promotional poster and bestseller list up to format W 11 3/8" x H 16 1/2"

Dimensions incl. metal bar	16 1/2" x 3/4" x 27 1/2"
----------------------------	--------------------------

Order #
GMKFK440FL

ACCESSORY

POCKET DIVIDER

40 metal dividers, powder coated silver metallic, to build flexible compartments on the table top

Dimensions	4 1/2" x 1/4" x 6 1/2"
------------	------------------------

Order #
GMTZFTBWE

B211

BESTSELLER TABLE "TOP30"

With 42 stacking places for the presentation of Bestsellers, laminated chipboard black / grey, 4 castors, 2 locks

Stacking area	3rd tier	7 3/4" x 7 3/4"
	2nd tier	31 3/4" x 31 3/4"
	1st tier	47 1/4" x 47 1/4"
Visible facings		42
Capacity		210
Dimensions		47 1/4" x 47 1/4" x 41"

Order #
FMT1040SW2

ACCESSORY

TOP 30 SIGNS

Set of 34 acrylic signs TOP 1-30, printed (red / white), which brackets adapt to the edge of the table and are adjustable in position (multiple signs for TOP 1-3 position)

Dimensions	3 1/4" x 2 1/4" x 1 1/4"
------------	--------------------------

Order #
FMTZWIFL30

B212

STACKING TABLE 2-TIER / 3-TIER

For the high-capacity presentation or large volume of mass-market merchandise. Sturdy quality with steel corner protection. Optional available with 4 castors, 4", 2 locks

Stacking area	3rd tier	31 1/2" x 47 1/4"
	2nd tier	47 1/4" x 47 1/4"
	1st tier	63" x 47 1/4"
Dimensions 2-tiers		63" x 47 1/4" x 33"
Dimensions 3-tiers		63" x 47 1/4" x 47 3/4"

Order #
FMMIPY-11WE (2-tiers, without castors)
FMMIPY-11WE2 (2-tiers, with castors)
FMMIPY-9WE (3-tiers, without castors)
FMMIPY-9WE4 (3-tiers, with castors)

B213

MOBILE DISPLAY TABLE

Woodgrain apple desk and bottom shelf, metal legs, silvermetallic, 4 castors, 2 locks. Use for display and organizing stock

Dimensions	34 3/4" x 23 3/4" x 27 1/2"
------------	-----------------------------

Order #
FMT700APNTR

YOUR BOOKTIQUE® – SHOP IN ONLY 3 STEPS.

Together with you and following your goals and requirements we create a layout and design and provide you with a concept for furnishing your location. A visualization helps to give you a first impression. Based on the final planning and after careful production we install the furniture on site.

Appealing and highly functional: the Booktique® system and fixtures are made-to-purpose. Special shelves and displays comfort books, magazines and other media product as well as non-book items, stationary and gifts.

1 Furnishing Concept

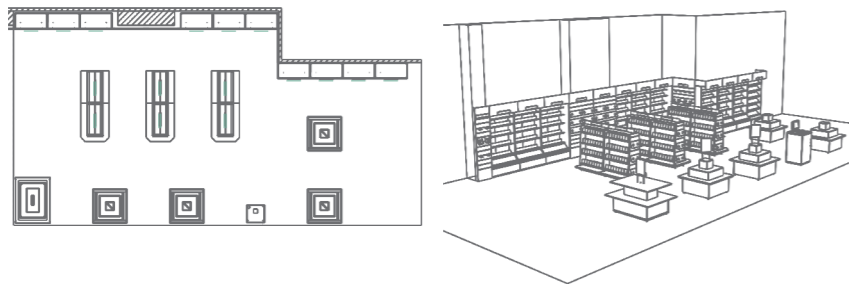

2 Visualization



3 Realization



▶ BOOKTIQUE® – SYSTEMATIC VARIETY

TOP AND HEADER MODELS

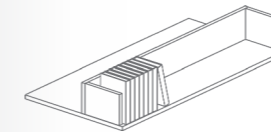

Open storage top

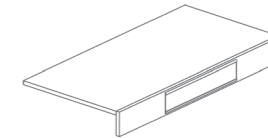

Flat top with light and header panel

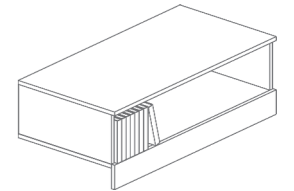

Storage top with light and header panel

TYPES OF SIDES AND BACK WALLS

Option: slat wall and screens

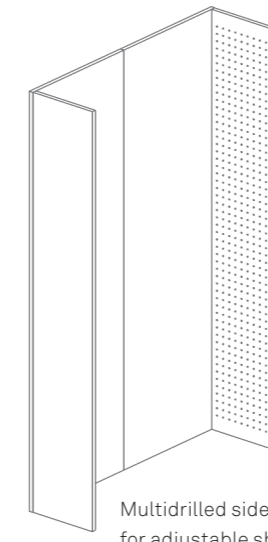

Multidrilled sides for adjustable shelves

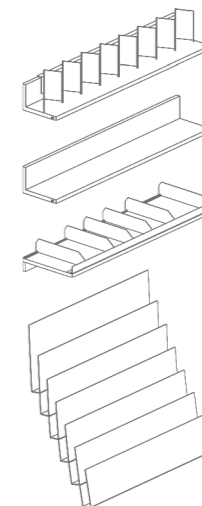

VARIETY OF SHELVES

For different product assortments

BASE MODELS

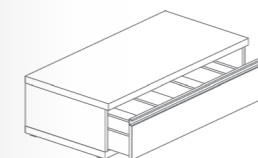

With drawer

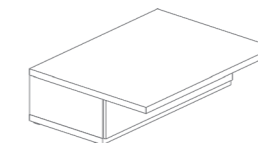

Extended stacking space

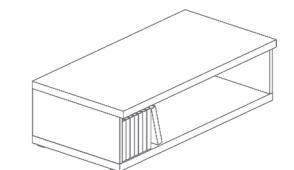

Open storage

BOOKTIQUE®.

► PRECONFIGURED FIXTURES

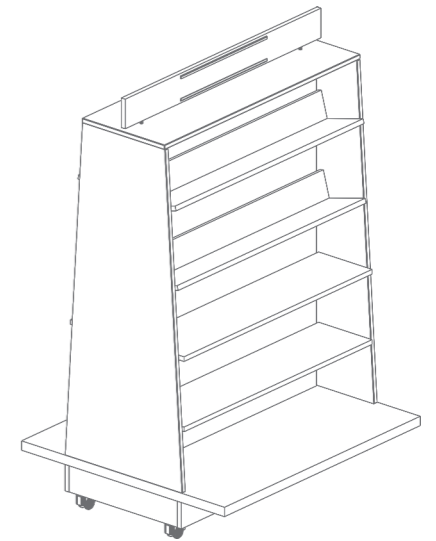
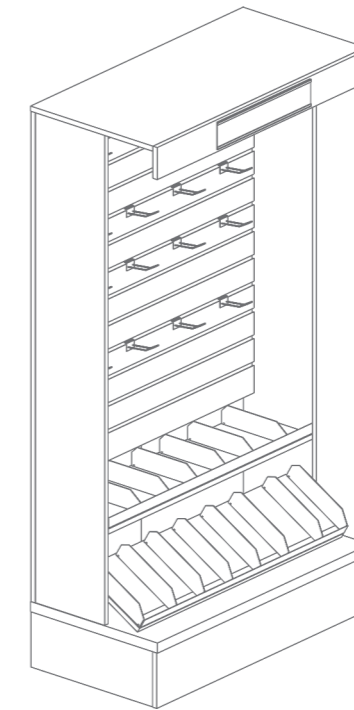
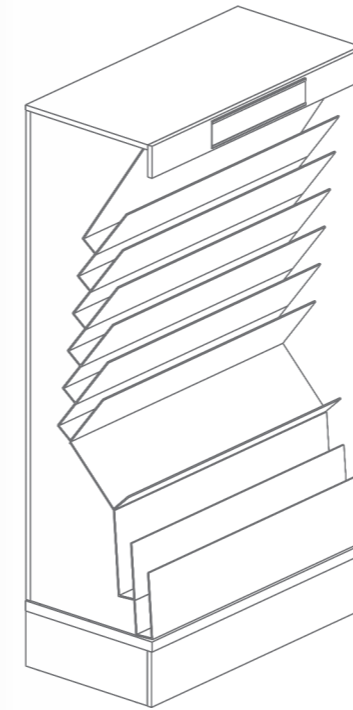
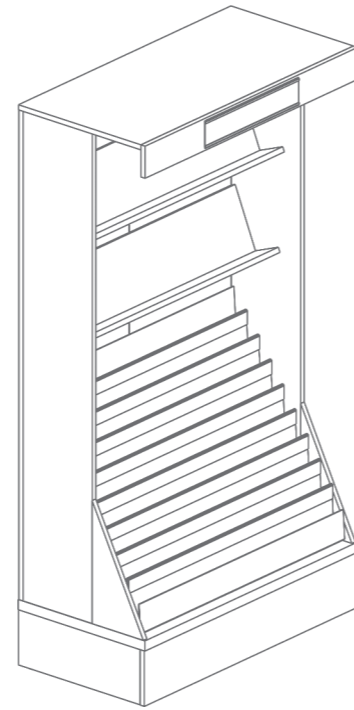
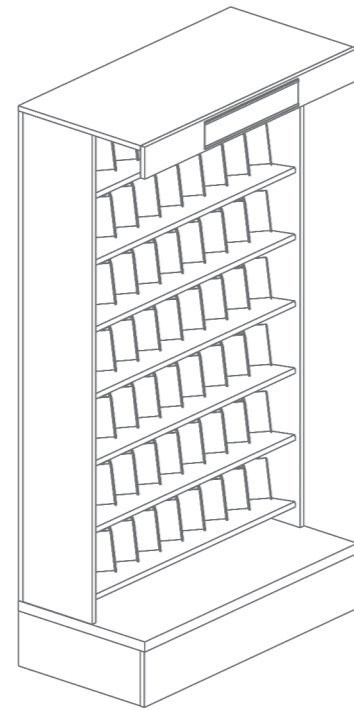
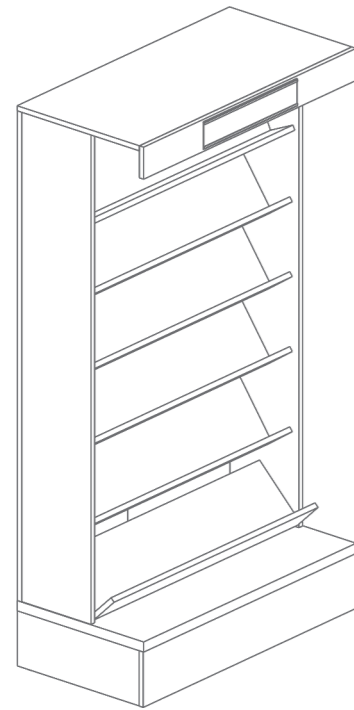

B201 WALL UNIT MIXED FORMATS

Basic version
Wall unit with enclosed base, cross header panel with sign holder, lighting, 6 shelf boards

Shelf width	43"
Shelf depth	43 1/4"
Shelf back	9 1/2"
Dimensions	44 3/4" x 22 1/4" x 85 1/2"

Order #
FBWG2B6WWE

B202 WALL UNIT PAPERBACKS

Basic version
Wall unit with enclosed base, cross header panel with sign holder, lighting, 7 shelf boards with zig-zag inserts up to 8 1/4 inch size books

Shelf width	43"
Shelf depth	7 3/4"
Pocket depth	3 1/4"
Pocket width	4 1/4"
Zig-zag insert	9 pockets each
Dimensions	44 3/4" x 22 1/4" x 85 1/2"

Order #
FBWG2B7W7ZWE

B203 WALL UNIT CARTOGRAPHY

Basic version
Wall unit with enclosed base, cross header panel with sign holder, lighting, 3 shelf boards, 8-pocket "waterfall unit"

Shelf width	43"
Shelf depth	7"
Shelf back	4 1/4"
Pocket depth waterfall unit	15 3/4"
Dimensions	44 3/4" x 22 1/4" x 85 1/2"

Order #
FBWG2B8C3WWE

B204 WALL UNIT MAGAZINES

Basic version
Wall unit with enclosed base, cross header panel with sign holder, lighting, 8 acrylic inserts, 1 acrylic shelf for mass market titles

Pocket width	2 1/2"
Pocket depth	44 3/4"
Pocket height	11 3/4"
Dimensions	44 3/4" x 22 1/4" x 85 1/2"

Order #
FBWG2B8S1A...

B205 WALL UNIT STATIONERY

Basic version
Wall unit with enclosed base, cross header panel with sign holder, lighting, 2 shelves with adjustable pocket divider, 1 slat wall unit for hooks and acrylic displays, 20 single hooks, 4 3/4 inch

Shelf width	43"
Shelf depth	11 1/2"
Slat wall	9 slots
Dimensions	44 3/4" x 22 1/4" x 85 1/2"

Order #
FBWG2B1L2WWE

B206 ISLAND UNIT "A" DOUBLE-SIDED PRESENTATION

Basic version
Island unit with stacking area, double-sided cross header panel with sign holder, 8 shelf boards

Shelf width	43"
Shelf depth	7 3/4"
Stacking area per side	8 1/4"
Dimensions	44 3/4" x 39" x 63"

Order #
FBMA8W-5WE

BOOKTIQUE®.

► PRECONFIGURED FIXTURES

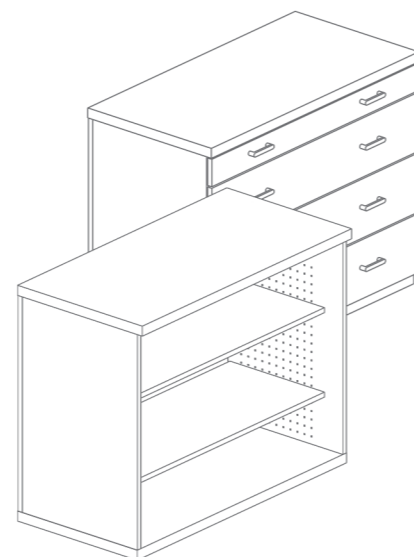
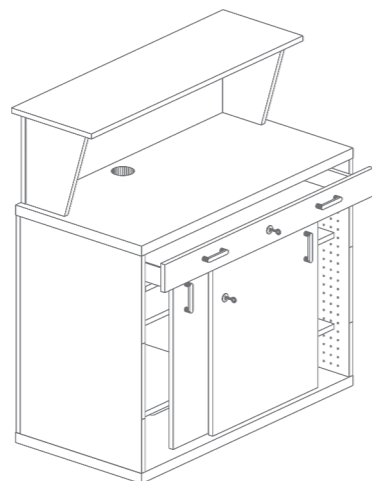
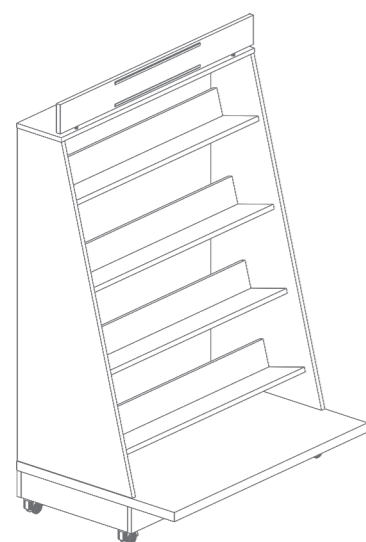

B207 ISLAND UNIT "G" ONE-SIDED PRESENTATION

Basic version
Island unit with stacking area, one-sided cross header panel with sign holder, 4 shelf boards

Shelf width	43"
Shelf depth	7 ¾"
Stacking depth	8 ¾"
Dimensions	44 ¾" x 39" x 63"

Order #
FBMG4W-5WE

B208 CASH POINT WITH TOPPER

Basic version
Island unit with 2 lockable sliding doors, 1 counter top, 1 lockable drawer, 2 height adjustable shelves

Drawer inside	39 ¾" x 19 ¼"
Counter top	14 ¼"
Dimensions	44 ¾" x 22 ¼" x 49 ½"

Order #
FBVHH2T-1WE

B209/B210 CASH POINT

Basic version
Island unit with 2 height adjustable shelves or alternatively with 4 drawers

Shelf width	39 ¾" x 21 ¼"
Shelf depth	39 ¾" x 19 ¼"
Dimensions	44 ¾" x 22 ¼" x 35 ½"

Order #
FBVHH4SWE (with drawers)
FBVHH2BWE (with shelves)

MORE INFORMATION.

Thank you for your attention and interest. We look forward to supporting you in successfully displaying and selling. If you want to find out more about our company and services, please contact us for further information.

MORE INFORMATION IS AVAILABLE ON FOLLOWING TOPICS:



- Display solutions: The Hannecke product-range
- Media Display: Display spinners and standard P.O.S. displays
- Exhibition systems and brochure stands: Display Spinners, DECOMOD® System
- Display configuration: easiKit® XL/CUBE, easiKit® XS

TRADE TERMS

Delivery Time
All In.Line Gondolas, In.Line Systems and shelves as well as tables from stock are available after approx. 6 weeks after order confirmation FOB Cranford/NJ. Booktique® is manufactured to your order, the time of delivery will be confirmed based on specification, quantity and finishing.

Colors and Finishes
Unless specified different in the catalog or in your order, we supply articles in the following color and finish from stock:
a) In.Line gondolas: metal components grey metallic (RAL9007), wooden parts "apple", b) In.Line Systems (Sets) and shelves for slotted metal uprights in silver metallic (RAL9006), wooden and plastic components matching similarly, c) Tables as specified, d) Booktique® fixtures are manufactured as specified with your order.

Headers
Unless specified different, all header signs or panels are supplied blank without print.

Article Specification
All dimensions "Width x Depth x Height" in inch. The indication of capacity is based on either the usual average in trade or on volume shown in the image.

Images
© Hannecke Display Systems GmbH & Co. KG – All rights reserved. All texts, images and diagrams in this catalogue are protected by copyright law and other intellectual property rights. All designs, sketches and drawings are subject to our copyright. Please refer to our national and international patents and patents pending. All images are illustrated examples. Hannecke Display Systems holds the image rights to the displays shown, but does not hold the rights to any reference materials shown in the display units. We herewith refer to third party property rights. Any use, processing or duplication, in whole or in part, requires our prior written approval.

Pricing and delivery
The product descriptions and prices refer only to the displays, not the products shown therein. We reserve the right to changing delivery options and making technical alterations. Our general terms and conditions apply.

CONTACT.

CONTACT ADDRESSES

Hannecke Display Systems GmbH & Co. KG

Rischenauweg 6
37154 Northeim
Germany

Phone: +49 (0) 55 51 5 99-0
Fax: +49 (0) 55 51 5 99-27
info@hannecke.de
www.hannecke.com

Hannecke Display Systems Inc.

91 Fulton Street #4
Boonton / NJ 07005
USA

Phone: 973-335-0434
Fax: 973-335-1274
info.usa@hannecke.com
www.hannecke.com



Follow-up online:
contact, catalogs,
pricelists and more!

HANNECKE